

UNDERWATER HYDRAULIC BREAKER SY-BR67320



SPECIFICATIONS

Performance	1300 bpm @ 8 gpm
Steel Capacity	1½" x 6" Hex
Handle Type	T-Handle
Circuit Type	Open Center
Flow Range	7-9 gpm / 26-34 lpm
Optimum Flow	8 gpm / 30 lpm
Working Pressure	1500-2000 psi / 105-140 bar
Full Relief Setting	2250 psi / 155 bar
Weight (less tool bit)	73 lbs / 33 kg
Length	29" / 73.6 cm
Width (at handles)	16" / 41 cm
Hydraulic Ports	-8 SAE O-ring
Couplers	No (See Accessories)
Hose Whips	Yes (¾" NPT Male thread)

FEATURES

- T-Handle with large on/off trigger for precise control
- Stainless Steel spool and fasteners
- Trouble free diaphragm accumulator provides additional blow energy and reduces recoil
- Feathering on/off valve allows easy initial tool bit placement
- Uses standard 1½" x 6" hex shank tool bits
- Four tie rod design for durability
- Operates in any position
- Modular design for ease of service
- Latch retainer



The **BR67** is a medium sized breaker in Stanley Hydraulic Tools line up of underwater paving breakers. The **BR67** is in the 70 lbs class of breakers and is used for medium concrete and rock breaking, coral removal and rod driving. The feathering on/off valve controls speed and allows easier initial tool placement. Standard 1½" x 6" hex chuck and latch retainer. Painted hi-visibility yellow.



UNDERWATER HYDRAULIC BREAKER SY-BR67320

ORDERING INFORMATION

PART NUMBER

BR67320 Paving Breaker, Underwater, 1 1/8" Hex, less couplers

ACCESSORIES

- 03971** Flush-Face Coupling Set, 3/8" NPT
- 03974** Flush-Face Coupling Set, 1/2" NPT
- 31848** Dual Hose, 50' x 1/2", with couplers
- 31972** Dual Hose, 25' x 1/2", with couplers
- 58633** Twinned Hose, 25' x 1/2", with couplers
- 58634** Twinned Hose, 50' x 1/2", with couplers
- 02331** Clay Spade, 1 1/8" Hex, 5 1/2" Wide Blade
- 02332** Asphalt Cutter, 1 1/8" Hex, 5" Wide Blade
- 02333** Moil Point, 1 1/8" Hex, 14" under collar
- 02334** 3" Wide Chisel, 1 1/8" Hex, 14" under collar
- 03990** Narrow Chisel, 1 1/8" Hex, 14" under collar
- 04176** Rod Driver, 1 1/8" Hex, 1" rod
- 08106** Asphalt Wedge, 1 1/8" Hex

When hydraulic hose exceeds 100' (30.4 m) in length, increase I.D. of both pressure and return hose. For more information, consult Stanley Hydraulic Tools.

IMPORTANT

To fill out a Product Warranty Recording form and for information on your warranty visit stanleyhydraulic.com and select the Warranty tab.

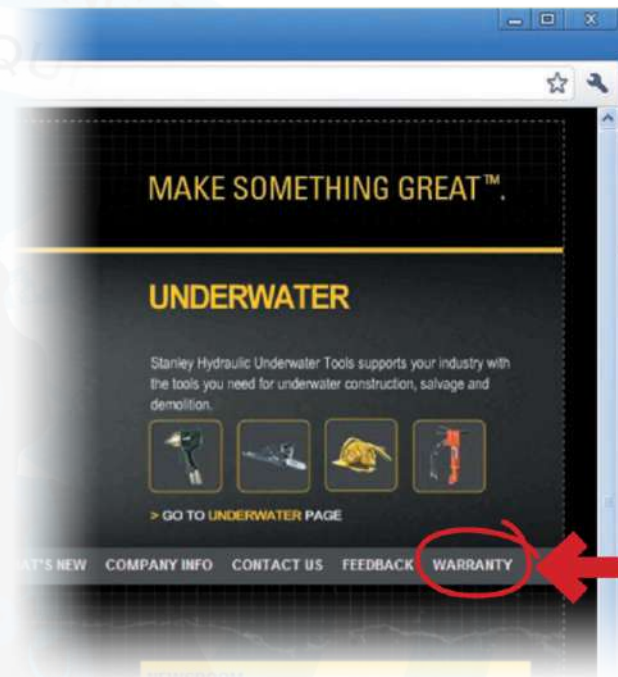



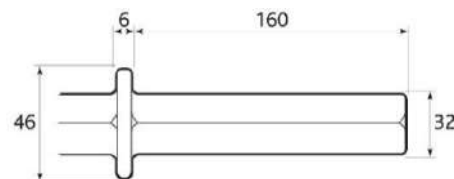

Note: The warranty recording form must be submitted to validate the warranty.

UNDERWATER HYDRAULIC BREAKER SY-BR67320

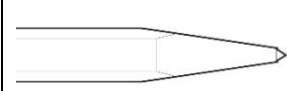
Shank Size: 32mm x 160mm (1-1/4" x 6-1/4")

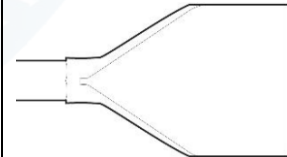
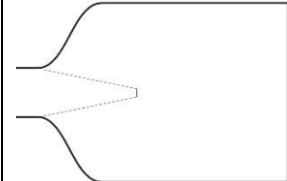

Description Part Number Length Under Collar Blade Size/Shape	Moil Point MP38032 380mm (15") Pointed End	MP45032 450mm (18") Pointed End	
Description Part Number Length Under Collar Blade Size/Shape	Narrow Chisel NC38032 380mm (15") 25mm (1") Wide	NC45032 450mm (18") 25mm (1") Wide	
Description Part Number Length Under Collar Blade Size/Shape	Broad Chisel BC38032 380mm (15") 75mm (3") Wide	BC45032 450mm (18") 75mm (3") Wide	
Description Part Number Length Under Collar Blade Size/Shape	Asphalt Cutter, Curved Edge AC33032 330mm (13") 125mm (5") Wide x 150mm (6")		
Description Part Number Length Under Collar Blade Size/Shape	Tarmac/Deltic Cutter TC28032 280mm (11") 115mm (4-1/2") Wide x 125mm (5")		
Description Part Number Length Under Collar Blade Size/Shape	Digger Spade DS35032 350mm (14") 125mm (5") Wide x 205mm (8")		

UNDERWATER HYDRAULIC BREAKER SY-BR67320

<p>Description Part Number Length Under Collar Blade Size/Shape</p>	<p>Clay Spade CS38032 380mm (15") 135mm (5-1/2") Wide x 205mm (8")</p>	
<p>Description Part Number Length Under Collar</p>	<p>Tamper Stem (Large Taper) TSL23032 230mm (9")</p>	
<p>Description Part Number Blade Size/Shape</p>	<p>Round Tamper Pad (Large Bore) TPL125R TPL180R 125mm (5") Dia 180mm (7") Dia</p>	
<p>Description Part Number Blade Size/Shape</p>	<p>Square Tamper Pad (Large Bore) TPL160S 160mm (6-1/4") Square</p>	
<p>Description Part Number</p>	<p>Accumulator Tester / Charger 02835</p>	
<p>Description Part Number</p>	<p>Accumulator Charging Hose Kit BCHA/1B</p>	

UNDERWATER HYDRAULIC BREAKER SY-BR67320

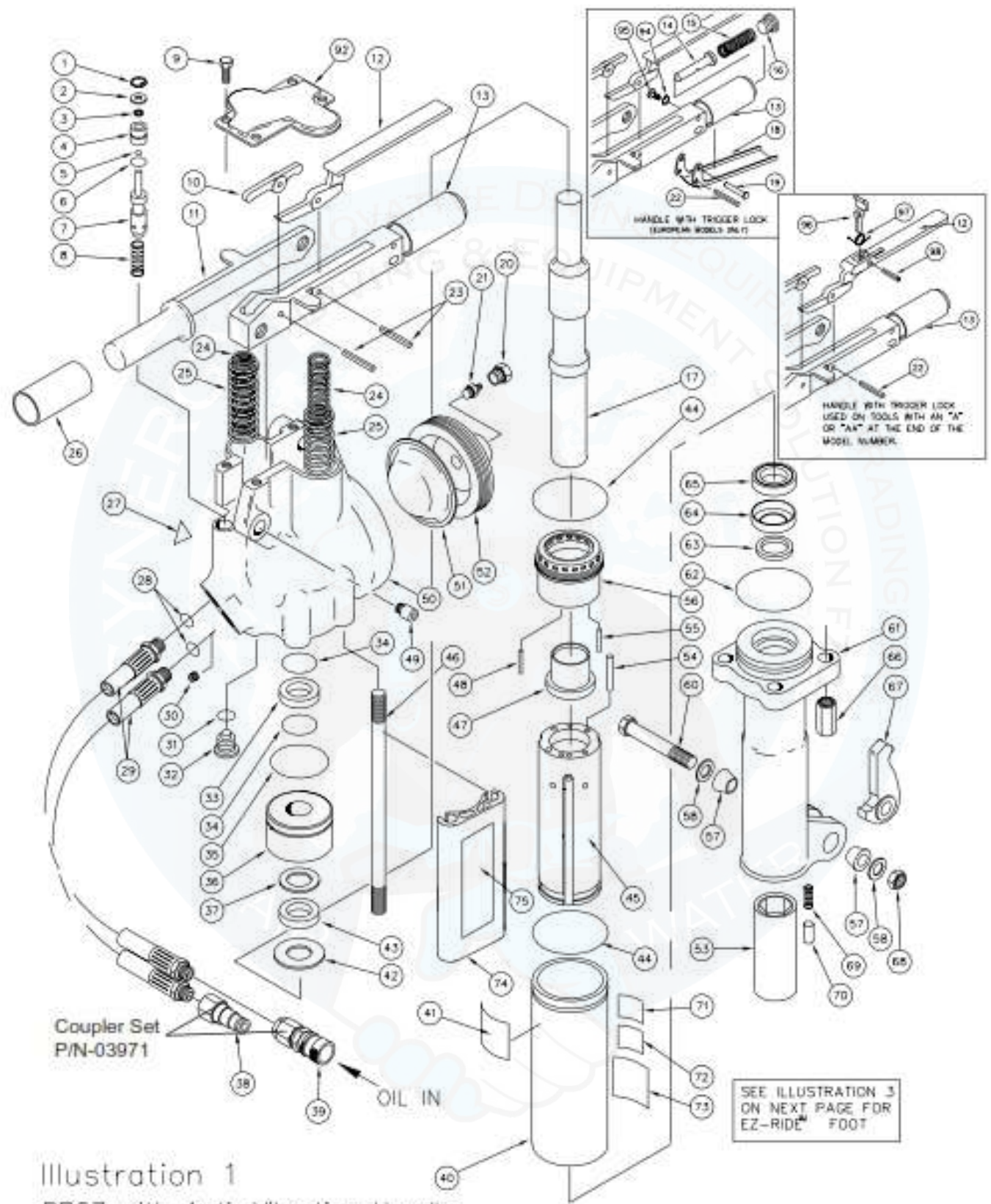

Illustration 1
BR67 with Anti-Vibration Handle
 August 2012

UNDERWATER HYDRAULIC BREAKER SY-BR67320

ITEM NO.	WITHOUT TRIGGER LOCK	WITH TRIGGER LOCK	QTY	DESCRIPTION
1	24067	24067	1	RETAINING RING
2	04055	04055	1	WASHER
3	04056	04056	1	ROD WIPER
4	26451	26451	1	BUSHING
5	01362	01362	1	O-RING
6	00293	00293	1	O-RING
7	20515	20515	1	VALVE SPOOL
8	04058	04058	1	SPRING
9	07628	07628	4	CAPSCREW
10	20511	20511	1	LEVER
11	28369	28369	1	HANDLE
12	20502	20502 58526	1 1	TRIGGER TRIGGER (USED ON TOOLS WITH AN "A" OR "AA" AT THE END OF THE MODEL NUMBER)
13	29045	29045 58529	1 1	TRIGGER HANDLE TRIGGER HANDLE (USED ON TOOLS WITH AN "A" OR "AA" AT THE END OF THE MODEL NUMBER)
14	—	26599	1	PIN
15	—	24964	1	SPRING
16	—	16607	1	SAE PLUG, -10
17	04070	04070	1	PISTON
18	—	24948	1	TRIGGER LOCK
19	—	31917	1	PIN
20	07493	07493	1	PLUG
21	20499	20499	1	CHARGE VALVE
22	—	21089	1	ROLL PIN
23	20500	20500	2	SPIROL PIN
24	20541	20541	2	SPRING
25	20498	20498	2	SPRING
26	02494	02494	2	HANDLE GRIP
27	11207	11207	1	CIRCUIT TYPE "D" STICKER (CE ONLY)
28	01605	01605	2	O-RING
29	01652	01652	2	HOSE ASSY (INCL ITEM 28)
30	12832	12832	1	ORIFICE PLUG
31	06891	06891	1	O-RING
32	31067	31067	1	PLUG
33	26452	26452	1	SINTERED FILTER
34	04795	04795	2	O-RING
35	16732	16732	1	O-RING
36	26448	26448	1	SPACER

ITEM NO.	WITHOUT TRIGGER LOCK	WITH TRIGGER LOCK	QTY	DESCRIPTION
37	04062	04062	1	BACK-UP WASHER
38	03973	03973	1	MALE COUPLER BODY
39	03972	03972	1	FEMALE COUPLER BODY
40	04068	04068	1	FLOW SLEEVE TUBE
41	74668	74668	1	NAME TAG, BR67
42	04064	04064	1	WASHER
43	04063	04063	1	CUP SEAL
44	04054	04054	2	O-RING
45	04069	04069	1	FLOW SLEEVE (SEE NOTE PAGE 20)
46	04071	04071	4	SIDE ROD
47	04065	04065	1	AUTOMATIC VALVE
48	04571	04571	2	PUSH PIN
49	20508	20508	2	PIVOT SCREW
50	26596	26596	1	ACCUMULATOR VALVE BLOCK
51	26574	26574	1	ACCUMULATOR DIAPHRAGM
52	26449	26449	1	ACCUMULATOR PLUG
53	04081	04081	1	HEX BUSHING, 1-1/8 X 6 IN. (FOR 04598 FOOT)
	04597	04597	1	HEX BUSHING, 1-1/4 X 6 IN. (FOR 04598 FOOT)
54	04067	04067	4	PUSH PIN
55	07890	07890	1	ROLL PIN
56	04066	04066	1	AUTOMATIC VALVE BODY
57	01269	01269	2	RUBBER SLEEVE
58	04985	04985	2	SPRING WASHER
59	—	—	1	HANDLE
60	04983	04983	1	BOLT
61	04598	04598	1	FOOT (FOR 04081 OR 04597 HEX BUSHING) (INCL 63 & 64)
	05466	05466	1	FOOT ASSY, 1-1/8 X 6 IN. HEX (USA & CE EXCEPT UK MODELS ONLY) (INCL ITEMS 53, 57-58, 60-61, 63-64, 66-70)
	05467	05467	1	FOOT ASSY, 1-1/4 X 6 IN. HEX (USA & CE EXCEPT UK MODELS ONLY) (INCL ITEMS 53, 57-58, 60-61, 63-64, 66-70)
62	04073	04073	1	O-RING
63	04074	04074	1	ROD WIPER
64	05464	05464	1	SEAL INSERT
65	34127	34127	1	CUP SEAL
66	04075	04075	4	SIDE ROD NUT

UNDERWATER HYDRAULIC BREAKER SY-BR67320

ITEM NO.	WITHOUT TRIGGER LOCK	WITH TRIGGER LOCK	QTY	DESCRIPTION
67	01837	01837	1	LATCH
68	04984	04984	1	STOP NUT
69	01744	01744	1	SPRING
70	08411	08411	1	DETENT
71	—	28322	1	CE STICKER (CE ONLY)
72	28409	28409	1	COMPOSITE STICKER (CE ONLY)
73	66654	66654	1	GUARANTEED SOUND POWER LEVEL STICKER 105 (CE ONLY)
74	73025	73025	2	FILLER SNAP-ON
75	74832	74832	2	STANLEY LOGO STICKER (USED ON: BR67125, BR67135 AND BR6717801A)
	74770		2	STANLEY LOGO STICKER (USED ON: BR6713516,
81	—	11230	1	HEX BUSHING, 1-1/4 X 6-1/4 IN. (FOR 12294 EZ FOOT)
82	—	—	1	SPRING
83	—	11234	1	COLLAR SUPPORT, 1-1/8 IN. (FOR 12294 EZ FOOT)
85	—	—	1	RETAINING RING
	—	12294	1	FOOT, EZ (FOR 11230 BUSHING) (UK MODELS ONLY) (INCL ITEMS 64, 87)
	—	11638	1	FOOT ASSY, EZ, 1-1/4 X 6-1/4 HEX (UK MODELS ONLY) (INCL ITEMS 53, 57-58, 60-61, 63-64 & 66-70, 81-83, 85, 87)
92	26450	26450	1	TOP PLATE

ITEM NO.	WITHOUT TRIGGER LOCK	WITH TRIGGER LOCK	QTY	DESCRIPTION
93	—	11208	1	HEX SHANK STICKER (UK MODELS ONLY)
94	—	00077	1	RETAINING RING (CHECK ITEM # 19 TO SEE IF IT USES A SCREW OR RET. RING)
95	—	32297	1	TRUSS HEAD SCREW (CHECK ITEM # 19 TO SEE IF IT USES A SCREW OR RET. RING)
96	—	58527	1	TRIGGER LOCK (USED ON TOOLS WITH AN "A" OR "AA" AT THE END OF THE MODEL NUMBER)
97	—	66828	1	TORSION SPRING (USED ON TOOLS WITH AN "A" OR "AA" AT THE END OF THE MODEL NUMBER)
98	—	07624	1	ROLL PIN (USED ON TOOLS WITH AN "A" OR "AA" AT THE END OF THE MODEL NUMBER)
	04596	04596	1	SEAL KIT

NOTE: There is a low sleeve kit available P/N-74396 that includes:
item # 44 (Qty-2 04054 o-ring),
item # 54 (qty-4 04067 push pin),
item # 45 (qty-1 04069 low sleeve),
item # 62 (qty-1 04073 o-ring)
and inst sheet.

UNDERWATER HYDRAULIC BREAKER SY-BR67320

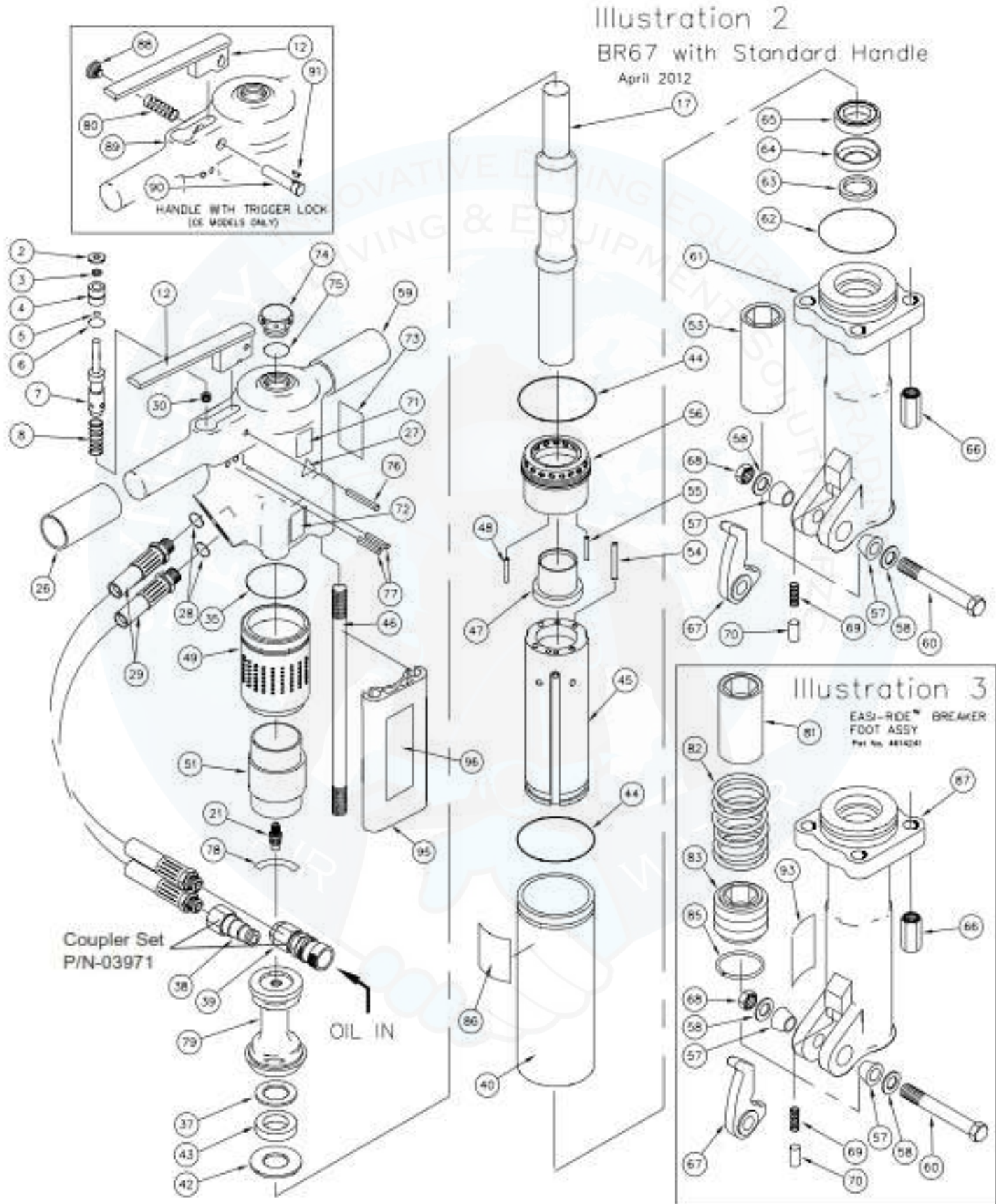

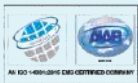

UNDERWATER HYDRAULIC BREAKER SY-BR67320

ITEM NO.	WITHOUT TRIGGER LOCK	WITH TRIGGER LOCK	QTY	DESCRIPTION
2	04055	04055	1	WASHER
3	04056	04056	1	ROD WIPER
4	04057	04057	1	BUSHING
5	01362	01362	1	O-RING
6	00293	00293	1	O-RING
7	04077	04077	1	VALVE SPOOL
8	04058	04058	1	SPRING
12	04053	11434	1	TRIGGER
17	04070	04070	1	PISTON
21	04051	04051	1	CHARGE VALVE
	09349	09349	1	VALVE CAP (NOT SHOWN)
26	02494	02494	2	HANDLE GRIP
27	—	11207	1	CIRCUIT TYPE "D" STICKER (CE ONLY)
28	01605	01605	2	O-RING
29	01652	01652	2	HOSE ASSY (INCL ITEM 28)
30	04350	04350	1	ORIFICE PLUG
35	04054	04054	1	O-RING
36	—	—	1	SPACER
37	04062	04062	1	BACK-UP WASHER
38	03971	03971	1	COUPLER SET (MALE & FEMALE COUPLERS)
39	03971	03971	1	COUPLER SET (MALE & FEMALE COUPLERS)
40	04068	04068	1	FLOW SLEEVE TUBE
42	04064	04064	1	WASHER
43	04063	04063	1	CUP SEAL
44	04054	04054	2	O-RING
45	04069	04069	1	FLOW SLEEVE (SEE NOTE PAGE 23)
46	04071	04071	4	SIDE ROD
47	04065	04065	1	AUTOMATIC VALVE
48	04571	04571	2	PUSH PIN
49	04060	04060	1	ACCUMULATOR CYLINDER
51	04059	04059	1	ACCUMULATOR DIAPHRAGM
53	04081	04081	1	HEX BUSHING, 1-1/8 × 6 IN. (FOR 04598 FOOT)
	04597	04597	1	HEX BUSHING, 1-1/4 × 6 IN. (FOR 04598 FOOT)
54	04067	04067	4	PUSH PIN
55	07890	07890	1	ROLL PIN
56	04066	04066	1	AUTOMATIC VALVE BODY
57	01269	01269	2	RUBBER SLEEVE
58	04985	04985	2	SPRING WASHER
59	04049	11435	1	HANDLE
60	04983	04983	1	BOLT

ITEM NO.	WITHOUT TRIGGER LOCK	WITH TRIGGER LOCK	QTY	DESCRIPTION
61	04598	04598	1	FOOT (FOR 04081 OR 04597 HEX BUSHING) (INCL 63 & 64)
	05466	05466	1	FOOT ASSY, 1-1/8 × 6 IN. HEX (USA & CE EXCEPT UK MODELS ONLY) (INCL ITEMS 53, 57-58, 60-61, 63-64, 66-70)
	05467	05467	1	FOOT ASSY, 1-1/4 × 6 IN. HEX (USA & CE EXCEPT UK MODELS ONLY) (INCL ITEMS 53, 57-58, 60-61, 63-64, 66-70)
	08855		1	BREAKER FOOT ASSY 1-1/8 U/W (MODEL BR67320 ONLY)
62	04073	04073	1	O-RING
63	04074	04074	1	ROD WIPER
64	05464	05464	1	SEAL INSERT
65	34127	34127	1	CUP SEAL
66	04075	04075	4	SIDE ROD NUT
67	01837	01837	1	LATCH
68	04984	04984	1	STOP NUT
69	01744	01744	1	SPRING
70	08411	08411	1	DETENT
71	—	28322	1	CE STICKER (CE ONLY)
72	28409	28409	1	COMPOSITE STICKER (CE ONLY)

UNDERWATER HYDRAULIC BREAKER SY-BR67320

ITEM NO.	WITHOUT TRIGGER LOCK	WITH TRIGGER LOCK	QTY	DESCRIPTION
73	66654	66654	1	GUARANTEED SOUND POWER LEVEL STICKER 105 (CE ONLY)
74	04050	04050	1	VALVE CAP ASSY (INCLUDES ITEM 75)
75	04052	04052	1	O-RING
76	00844	00844	1	SPIROL PIN
77	22891	22891	1	SPRING PIN
78	10180	10180		STICKER
79	04061	04061	1	ACCUMULATOR CHAMBER
80	—	11430	1	SPRING
81	07517	07517	1	HEX BUSHING, 1-1/8 × 6 IN. (FOR 11614 EZ FOOT)
	07518	07518	1	HEX BUSHING, 1-1/4 × 6 IN. (FOR 11614 EZ FOOT)
	—	11230	1	HEX BUSHING, 1-1/4 × 6-1/4 IN. (FOR 12294 EZ FOOT)
82	07514	07514	1	SPRING
83	08115	08115	1	COLLAR SUPPORT, 1-1/8 IN. (FOR 11614 EZ FOOT)
	08116	08116	1	COLLAR SUPPORT, 1-1/4 IN. (FOR 11614 EZ FOOT)
	—	11234	1	COLLAR SUPPORT, 1-1/4 IN. (FOR 12294 EZ FOOT)
84	—			NO ITEM
85	07522	07522	1	RETAINING RING
86	74667	74667	1	NAME TAG (T-HANDLE)
	74671			NAME TAG (T-HANDLE) BR67320 ONLY.
87	11614	11614	1	FOOT, EZ (FOR 07517 OR 07518 BUSHING) (USA & CE EXCEPT UK MODELS ONLY) (INCL ITEMS 64, 87)

ITEM NO.	WITHOUT TRIGGER LOCK	WITH TRIGGER LOCK	QTY	DESCRIPTION
	07525	07525	1	FOOT ASSY, EZ, 1-1/8 × 6 HEX (USA & CE EXCEPT UK MODELS ONLY) (INCL ITEMS 57-58, 60, 63-64, 66-70, 81-83, 85, 87)
	07524	07524	1	FOOT ASSY, EZ, 1-1/4 × 6 HEX (USA & CE EXCEPT UK MODELS ONLY) (INCL ITEMS 57-58, 60, 63-64, 66-70, 81-83, 85, 87)
	—	11638	1	FOOT ASSY, EZ, 1-1/4 × 6-1/4 HEX (UK MODELS ONLY) (INCL ITEMS 53, 57-58, 60-61, 63-64 & 66-70, 81-83, 85, 87)
88	—	01003	1	BUTTON
89	—	11435	1	HANDLE
90	—	11431	1	LOCK PIN
91	—	11432	1	KEY
93	—	11208	1	HEX SHANK STICKER (UK MODELS ONLY)
94	—	00077	1	RETAINING RING
95	73025	73025	2	FILLER SNAP-ON
96	74832	74832	2	STANLEY LOGO STICKER (USED ON MODELS: BR67120, BR67120E, BR67130, BR67130E).
	74770		2	STANLEY LOGO STICKER (USED ON MODELS: BR67120D and BR67320).
	04596	04596	1	SEAL KIT



NOTE: There is a low sleeve kit available P/N-74396 that includes:
item # 44 (Qty-2 04054 o-ring),
item # 54 (qty-4 04067 push pin),
item # 45 (qty-1 04069 low sleeve),
item # 62 (qty-1 04073 o-ring)
and inst sheet.

UNDERWATER HYDRAULIC BREAKER SY-BR67320

Contact us

 29th Street, Amman Road, Behind Al Huraiz Est. For Industry,
Al Qusais, Industrial Area – 1,
Dubai, United Arab Emirates

-  Tel : 009714 2580533 
-  Fax : 042516664 
-  UAE : 00971505648178 
-  UK : 00447951966260 

-  Website : www.synergiequipment.com
-  Email : ram@synergiequipment.com
-  For Sale : info@synergiequipment.com

