

UNDERWATER HYDRAULIC BREAKER SY-BR87320



SPECIFICATIONS

Performance	1080 bpm @ 8 gpm
Steel Capacity	1 1/8" x 6" Hex
Handle Type	T-Handle
Circuit Type	Open Center
Flow Range	7-9 gpm / 26-34 lpm
Optimum Flow	8 gpm / 30 lpm
Working Pressure	1500-2000 psi / 105-140 bar
Full Relief Setting	2250 psi / 155 bar
Weight (at handles)	85 lbs / 39 kg
Length	29" / 73.6 cm
Width (less tool bit)	16" / 41 cm
Hydraulic Ports	-8 SAE O-ring
Couplers	No (See Accessories)
Hose Whips	Yes (3/8" NPT Male thread)

FEATURES

- T-Handle with large on/off trigger for precise control
- Stainless Steel spool and fasteners
- Trouble free diaphragm accumulator provides additional blow energy and reduces recoil
- Feathering on/off valve allows easy initial tool bit placement
- Uses standard 1 1/8" x 6" hex shank tool bits
- Four tie rod design for durability
- Operates in any position
- Modular design for ease of service
- Latch retainer



The **BR87** is the largest breaker in Stanley Hydraulic Tools line up of underwater paving breakers. The **BR87** is in the 90 lb class of breakers and with its long piston stroke, is our hardest hitting hand held breaker. It is used for heavy concrete and rock breaking, coral removal and rod and anchor driving. The feathering on/off valve controls speed and allows easier initial tool placement. Standard 1 1/8" x 6" hex chuck and latch retainer. Painted hi-visibility yellow.



UNDERWATER HYDRAULIC BREAKER SY-BR87320

ORDERING INFORMATION

PART NUMBER

BR87320 Paving Breaker, Underwater, 1 1/8" Hex, less couplers

ACCESSORIES

- 03971** Flush-Face Coupling Set, 3/8" NPT
- 03974** Flush-Face Coupling Set, 1/2" NPT
- 31848** Dual Hose, 50' x 1/2", with couplers
- 31972** Dual Hose, 25' x 1/2", with couplers
- 58633** Twinned Hose, 25' x 1/2", with couplers
- 58634** Twinned Hose, 50' x 1/2", with couplers
- 02331** Clay Spade, 1 1/8" Hex, 5 1/2" Wide Blade
- 02332** Asphalt Cutter, 1 1/8" Hex, 5" Wide Blade
- 02333** Moil Point, 1 1/8" Hex, 14" under collar
- 02334** 3" Wide Chisel, 1 1/8" Hex, 14" under collar
- 03990** Narrow Chisel, 1 1/8" Hex, 14" under collar
- 04176** Rod Driver, 1 1/8" Hex, 1" rod
- 08106** Asphalt Wedge, 1 1/8" Hex

When hydraulic hose exceeds 100' (30.4 m) in length, increase I.D. of both pressure and return hose. For more information, consult Stanley Hydraulic Tools.

IMPORTANT

To fill out a Product Warranty Recording form and for information on your warranty visit stanleyhydraulic.com and select the Warranty tab.

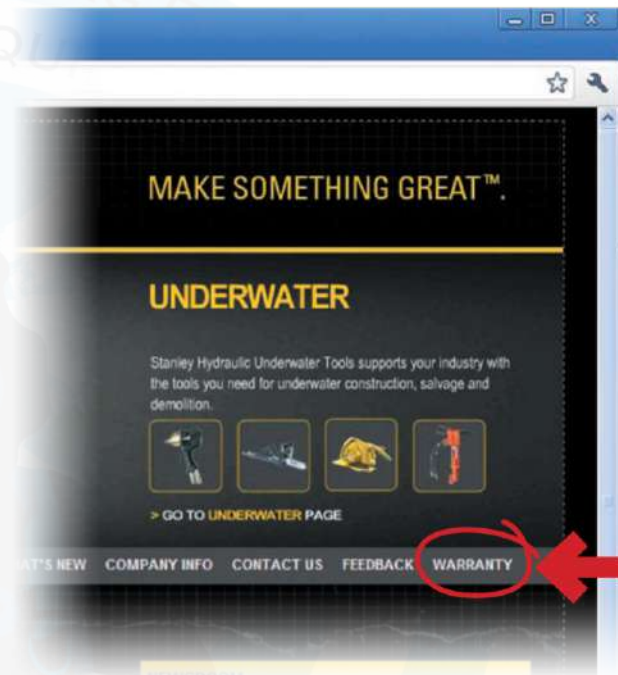

Note: The warranty recording form must be submitted to validate the warranty.



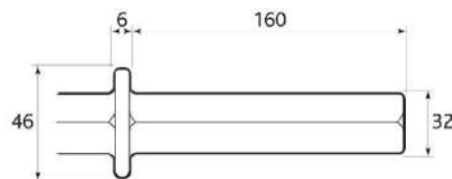

UNDERWATER HYDRAULIC BREAKER SY-BR87320

Shank Size: 32mm x 160mm (1-1/4" x 6-1/4")

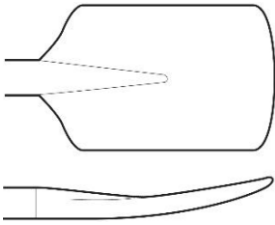
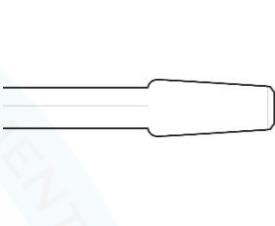
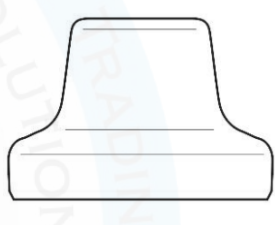

Description Part Number Length Under Collar Blade Size/Shape	Moil Point MP38032 380mm (15") Pointed End	MP45032 450mm (18") Pointed End	
Description Part Number Length Under Collar Blade Size/Shape	Narrow Chisel NC38032 380mm (15") 25mm (1") Wide	NC45032 450mm (18") 25mm (1") Wide	
Description Part Number Length Under Collar Blade Size/Shape	Broad Chisel BC38032 380mm (15") 75mm (3") Wide	BC45032 450mm (18") 75mm (3") Wide	
Description Part Number Length Under Collar Blade Size/Shape	Asphalt Cutter, Curved Edge AC33032 330mm (13") 125mm (5") Wide x 150mm (6")		
Description Part Number Length Under Collar Blade Size/Shape	Tarmac/Deltic Cutter TC28032 280mm (11") 115mm (4-1/2") Wide x 125mm (5")		
Description Part Number Length Under Collar Blade Size/Shape	Digger Spade DS35032 350mm (14") 125mm (5") Wide x 205mm (8")		

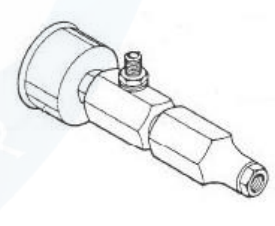
UNDERWATER HYDRAULIC BREAKER SY-BR87320

<p>Description Part Number Length Under Collar Blade Size/Shape</p>	<p>Clay Spade CS38032 380mm (15") 135mm (5-1/2") Wide x 205mm (8")</p>	
<p>Description Part Number Length Under Collar</p>	<p>Tamper Stem (Large Taper) TSL23032 230mm (9")</p>	
<p>Description Part Number Blade Size/Shape</p>	<p>Round Tamper Pad (Large Bore) TPL125R TPL180R 125mm (5") Dia 180mm (7") Dia</p>	
<p>Description Part Number Blade Size/Shape</p>	<p>Square Tamper Pad (Large Bore) TPL160S 160mm (6-1/4") Square</p>	
<p>Description Part Number</p>	<p>Accumulator Tester / Charger 02835</p>	
<p>Description Part Number</p>	<p>Accumulator Charging Hose Kit BCHA/1B</p>	

UNDERWATER HYDRAULIC BREAKER SY-BR87320

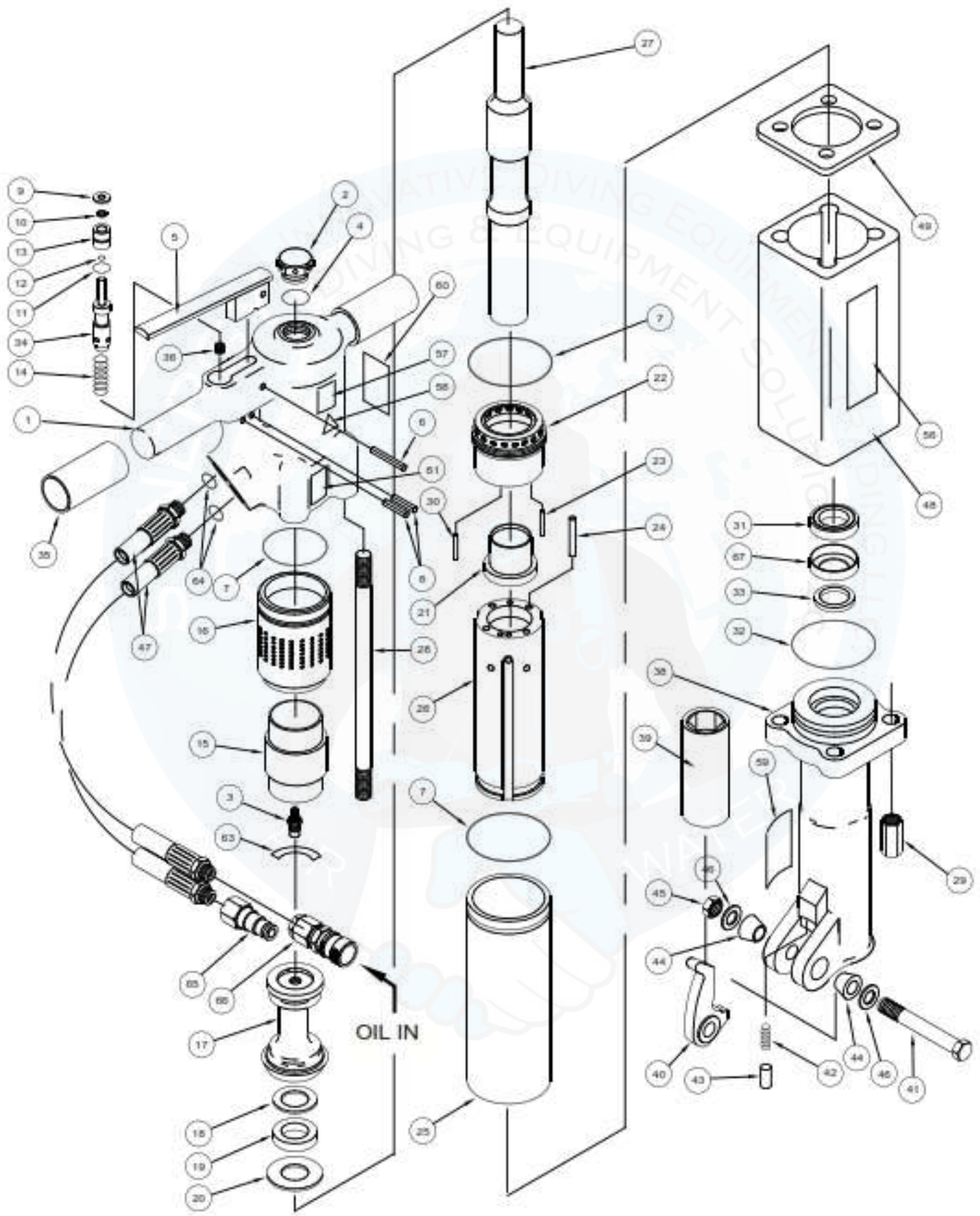

UNDERWATER HYDRAULIC BREAKER SY-BR87320

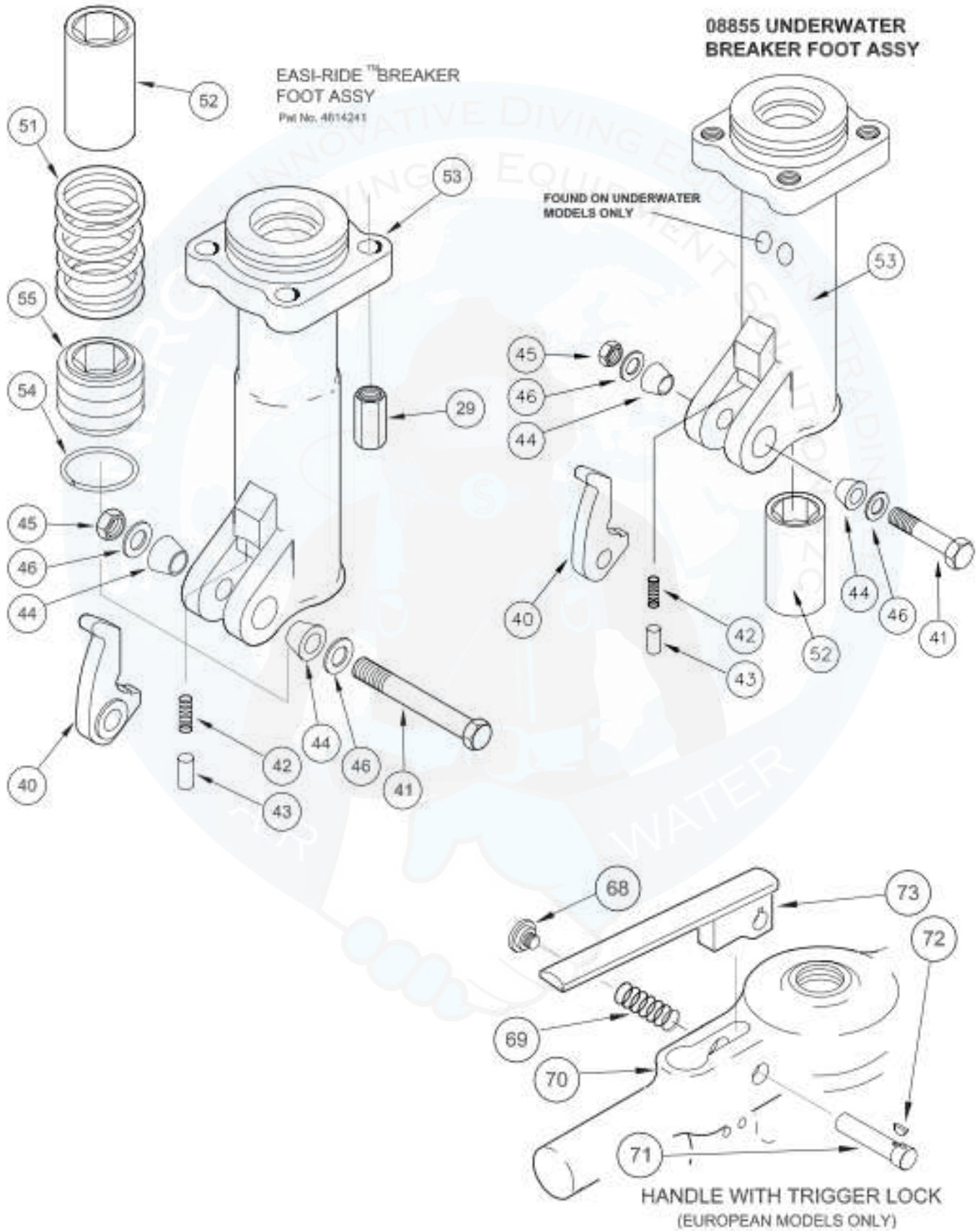

UNDERWATER HYDRAULIC BREAKER SY-BR87320

Item No.	Part No.	Qty	Description
1	06185	1	HANDLE ASSY (INCL ITEM 35)
	11435	1	BREAKER HANDLE (TRIGGER LOCK MODELS ONLY)
2	04050	1	VALVE CAP ASSY
3	04051	1	CHARGING VALVE
4	04052	1	O-RING
5	04053 11434	1	TRIGGER TRIGGER (TRIGGER LOCK MODELS ONLY)
6	00844	1	SPIROL PIN
7	04054	3	O-RING
8	22891	2	SPIROL PIN, 3/16 × 1-5/8
9	04055	1	WASHER
10	04056	1	ROD WIPER
11	00293	1	O-RING
12	01362	1	O-RING
13	04057	1	BUSHING
14	04058	1	SPRING
15	04059	1	ACCUMULATOR DIAPHRAGM
16	04060	1	ACCUMULATOR CYLINDER
17	05309	1	ACCUMULATOR CHAMBER ASSY
	06889	1	ACCUMULATOR ASSEMBLY (INCL ITEMS 3, 7, 15-19)
18	05301	1	BACK-UP WASHER
19	05307	1	CUP SEAL
20	04064	1	WASHER
21	04065	1	AUTOMATIC VALVE
22	04066	1	AUTOMATIC VALVE BODY
23	04571	2	PUSH PIN, 3/16 × 1-1/4
24	04067	4	PUSH PIN, 5/16 × 2
25	04068	1	FLOW SLEEVE TUBE
26	04069	1	FLOW SLEEVE (SEE NOTE ON THIS PAGE)
27	16812	1	PISTON
28	04071	4	SIDE ROD
29	04075	4	SIDE ROD NUT
30	07890	1	ROLL PIN, 3/16 × 1-1/2
31	34127	1	CUP SEAL
32	04073	1	O-RING
33	04074	1	ROD WIPER
34	04077	1	VALVE SPOOL, OC
35	02494	2	HANDLE GRIP
36	05465	1	ORIFICE PLUG
37	05466 05467	1	FOOT ASSY 1-1/8 HEX (INCL ITEMS 31-33 & 38-46 & 67) FOOT ASSY 1-1/4 HEX (INCL ITEMS 31-33 & 38-46 & 67)
38	05484	1	FOOT ASSY (INCL ITEMS 33-67)
	07523	1	EASI-RIDE™ FOOT ASSY 1-1/8 HEX (INCL ITEMS 33, 40-46 & 51-55)
	07486	1	EASI-RIDE™ FOOT ASSY 1-1/4 HEX (INCL ITEMS 33, 40-46 & 51-55)
39	04081 04597	1	HEX BUSHING, 1-1/8 HEX HEX BUSHING, 1-1/4 HEX
40	01837	1	LATCH
41	04983	1	BOLT
42	01744	1	SPRING
43	01745 08411	1	DETENT, 1.000 OAL (SERIAL NO. 1707 AND BELOW) DETENT, 1.250 OAL (SERIAL NO. 1708 AND ABOVE)
44	01269	2	RUBBER SLEEVE, 1.000
45	04984	1	STOP NUT

Item No.	Part No.	Qty	Description
46	04985	2	SPRING WASHER
47	09546	2	PIGTAIL HOSE ASSY
48	05265	1	FLOW SLEEVE HOUSING
49	24666	1	ELASTOMETRIC SPACER
51	07515	1	SPRING
52	07517 07518	1	HEX BUSHING, 1-1/8 HEX BUSHING, 1-1/4
	04081	1	HEX BUSHING, 1-1/8 U/W ONLY
53	11614	1	BREAKER FOOT ASSY
	08855	1	BREAKER FOOT ASSY U/W ONLY (INCL ITEMS 31-33, 40-46, 52, & 67)
54	07522	1	RETAINING RING
55	08115 08116	1	COLLAR SUPPORT ASSY 1-1/8 W/WEAR RINGS COLLAR SUPPORT ASSY 1-1/4 W/WEAR RINGS
56	74832	2	STANLEY LOGO DECAL (BLACK ON CLEAR)
	74770	2	STANLEY LOGO DECAL (USED ON MODELS BR87120D, BR87120J & BR87320 ONLY). YELLOW ON CLEAR.
57	28322	1	CE DECAL
58	11207	1	CIRCUIT TYPE "D" DECAL
59	11208	1	HEX SHANK LENGTH DECAL
60	72786	1	GUARANTEED SOUND POWER LEVEL DECAL
61	28409	1	COMPOSITE DECAL
62	—	—	NO ITEM
63	10180	1	CAUTION DECAL
64	01605	2	O-RING (INCL WITH ITEM 47)
65	03973	1	FLUSH FACE COUPLER, MALE
66	03972	1	FLUSH FACE COUPLER, FEMALE
	03971	1	COUPLER SET
67	05464	1	SEAL INSERT
68	01003	1	BUTTON
69	11430	1	SPRING
70	11435	1	HANDLE
71	11431	1	LOCK PIN
72	11432	1	KEY
73	11434	1	TRIGGER
	74673	1	NAME TAG BR87 (ATTACH NEAR ITEM 60)
	74666	1	NAME TAG BR87 (BR87120D ONLY)

NOTE: There is a low sleeve kit available P/N- 74396 that includes: item # 7 (Qty-2 04054 o-ring), item # 24 (qty-4 04067 push pin), item # 26 (qty-1 04069 low sleeve), item # 32 (qty-1 04073 o-ring) and inst sheet.



SEAL KIT PART NUMBER 05485		
Part No.	Qty	Description
00293	1	O-RING
00678	1	O-RING
01362	1	O-RING
01605	2	O-RING
04052	1	O-RING
04054	3	O-RING
04056	1	ROD WIPER
04073	1	O-RING
04074	1	ROD WIPER
05307	1	CUP SEAL
05641	1	O-RING
34127	1	CUP SEAL

UNDERWATER HYDRAULIC BREAKER SY-BR87320

Contact us

 29th Street, Amman Road, Behind Al Huraiz Est. For Industry,
Al Qusais, Industrial Area – 1,
Dubai, United Arab Emirates

-  Tel : 009714 2580533 
-  Fax : 042516664 
-  UAE : 00971505648178 
-  UK : 00447951966260 

-  Website : www.synergiequipment.com
-  Email : ram@synergiequipment.com
-  For Sale : info@synergiequipment.com

